

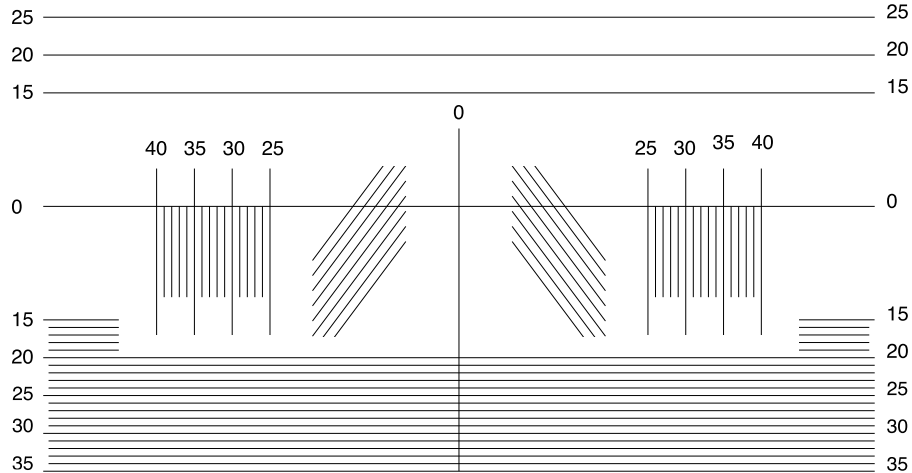

ZENTRIERSCHABLONEN



Zentrierhilfe und Informationen



Copyright und Markenzeichen

Transitions®

ist eingetragenes Warenzeichen
der Transitions Optical, Inc.

Sola®

ist ein eingetragenes Warenzeichen
der Carl Zeiss Vision GmbH.

Trivex®

ist ein eingetragenes Warenzeichen
der PPG Inc.

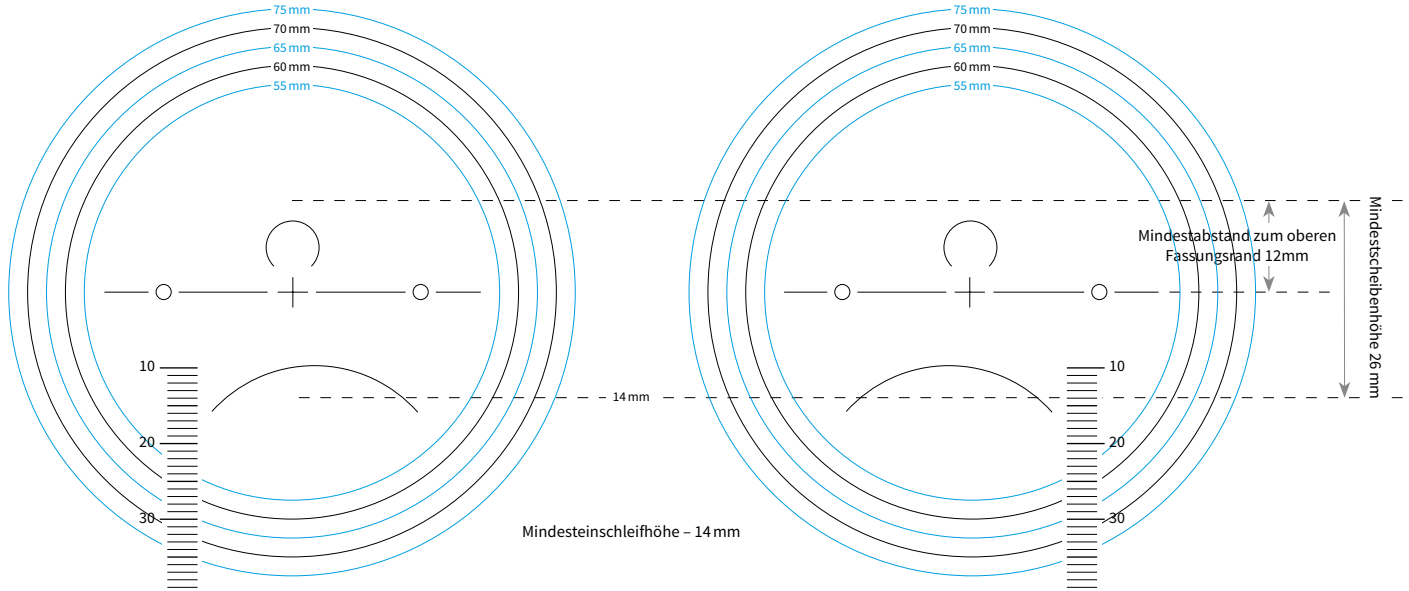

Perfect – Korridor 7 | 9 | 11 mm

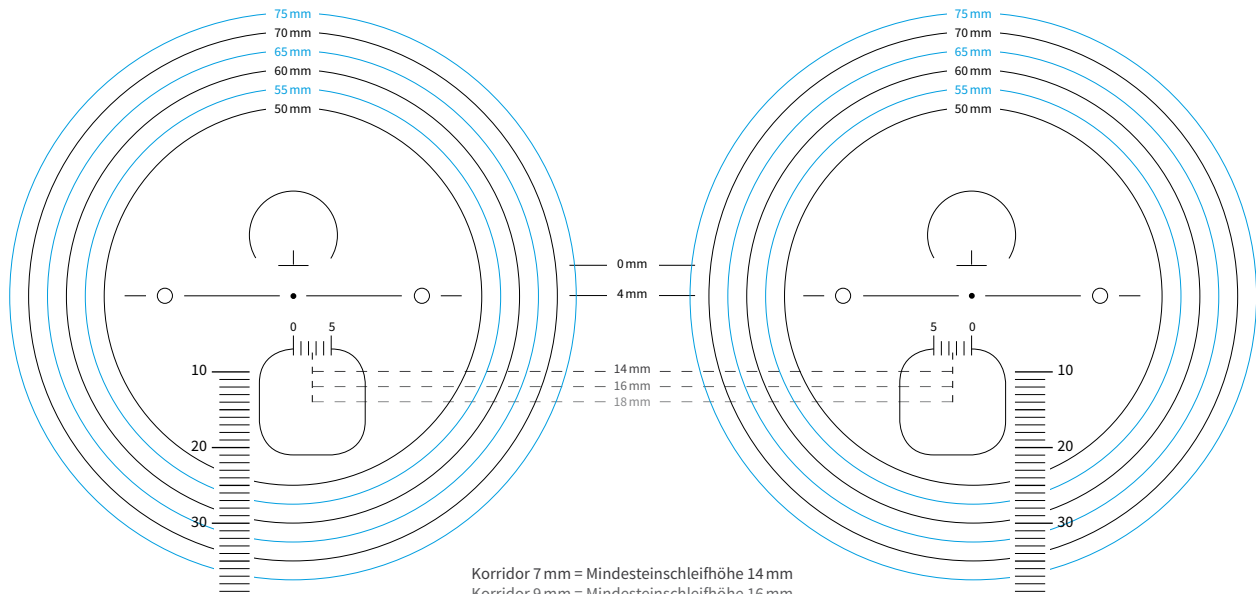

Korridor 7 mm = Mindesteinschleifhöhe 14 mm
 Korridor 9 mm = Mindesteinschleifhöhe 16 mm
 Korridor 11 mm = Mindesteinschleifhöhe 18 mm

Spontan IPR | Drive | Desktop – Korridor 9 | 11 | 13 mm

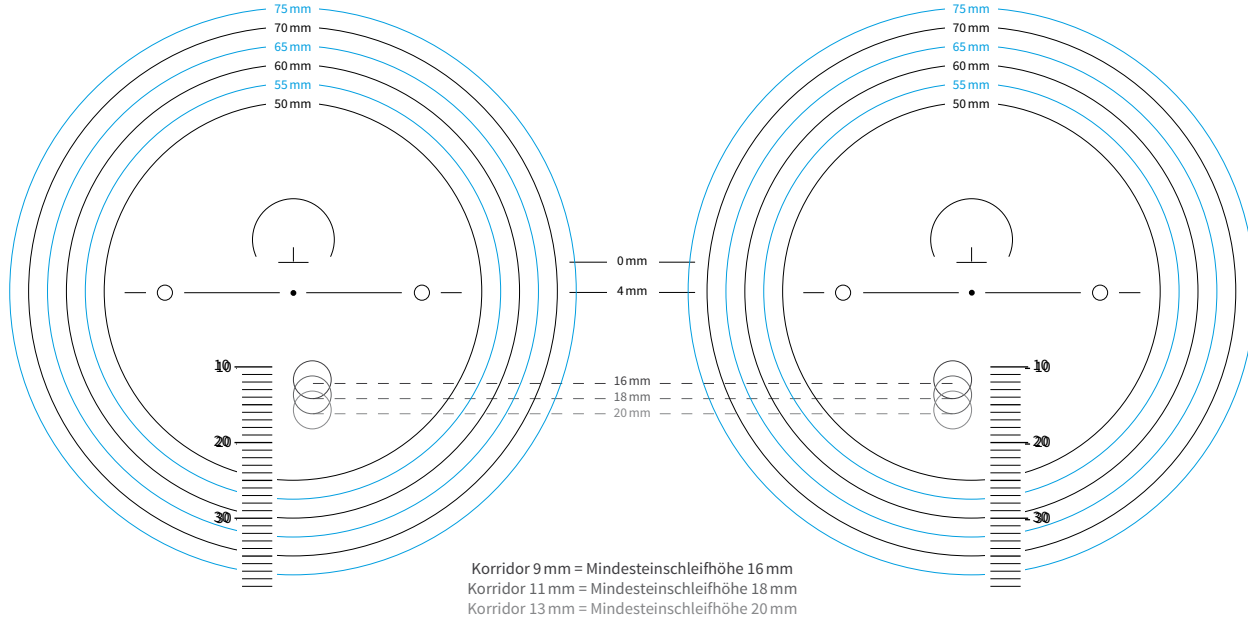

SportTech Perfect Progressiv – Korridor 11 mm

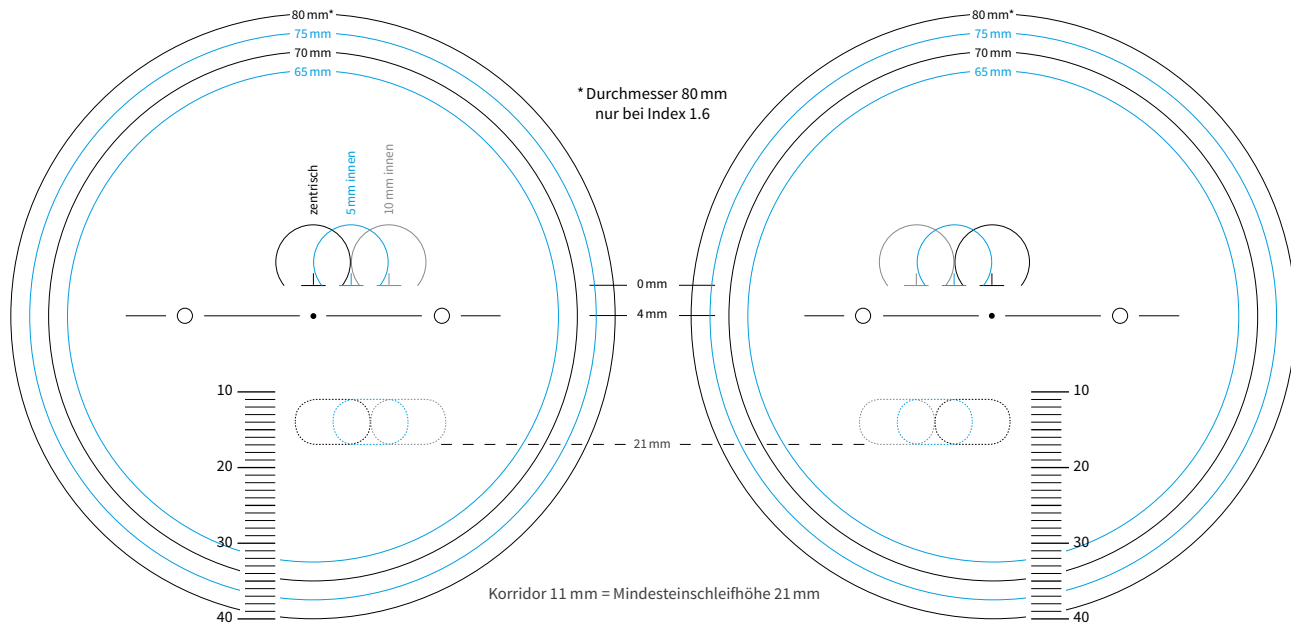

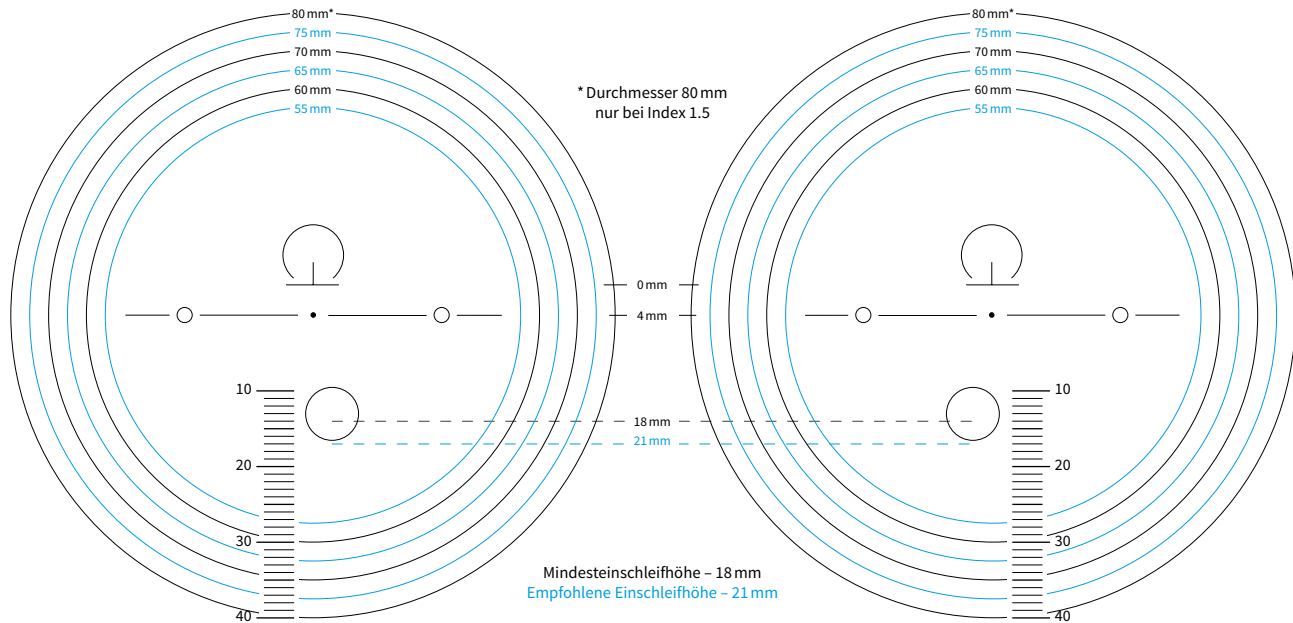

Organic Soft Spontan | Organic Soft Spontan λ Kantenfilter

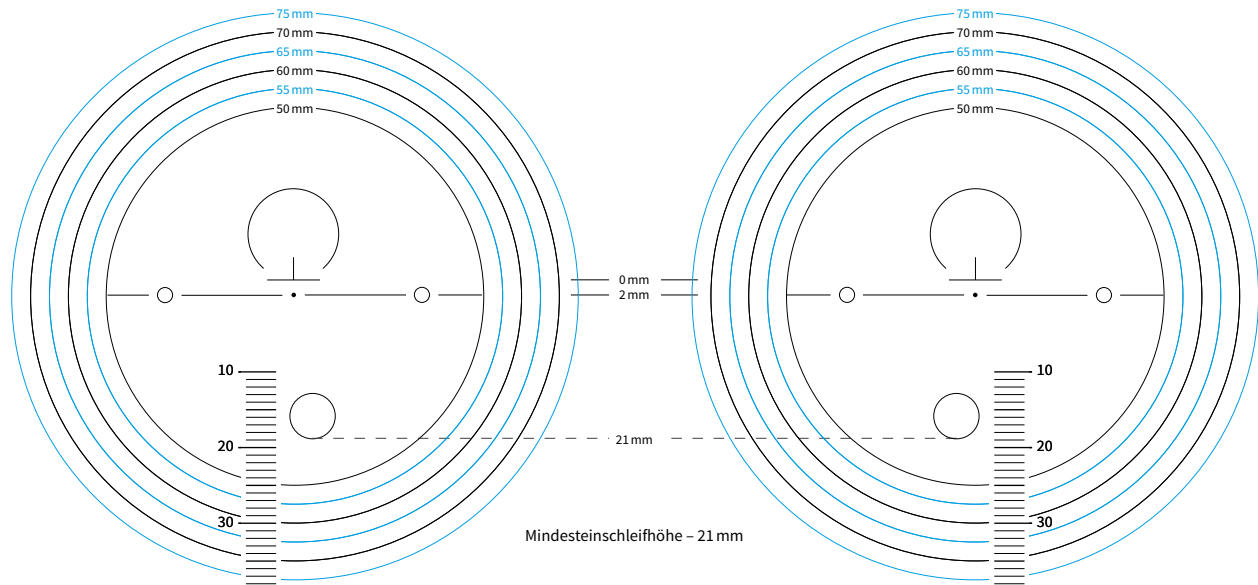

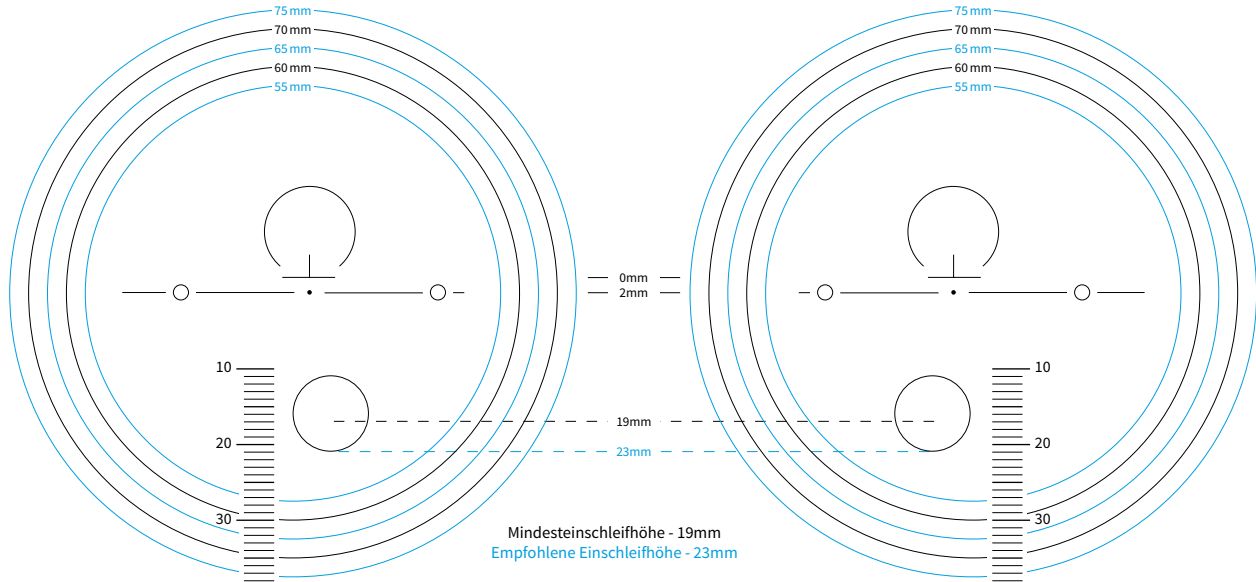
Organic Soft λ 1.5 | λ 1.5 POL Kantenfilter

Mineral Spontan 1.8 | 1.6 | 1.6 Photo

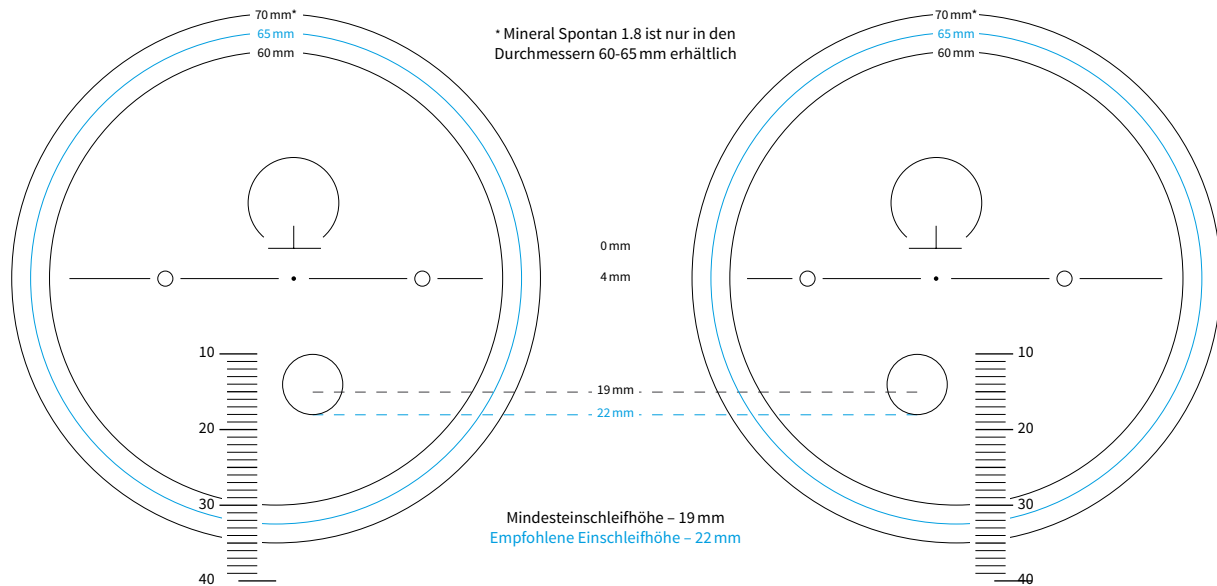

Mineral Spontan 1.52

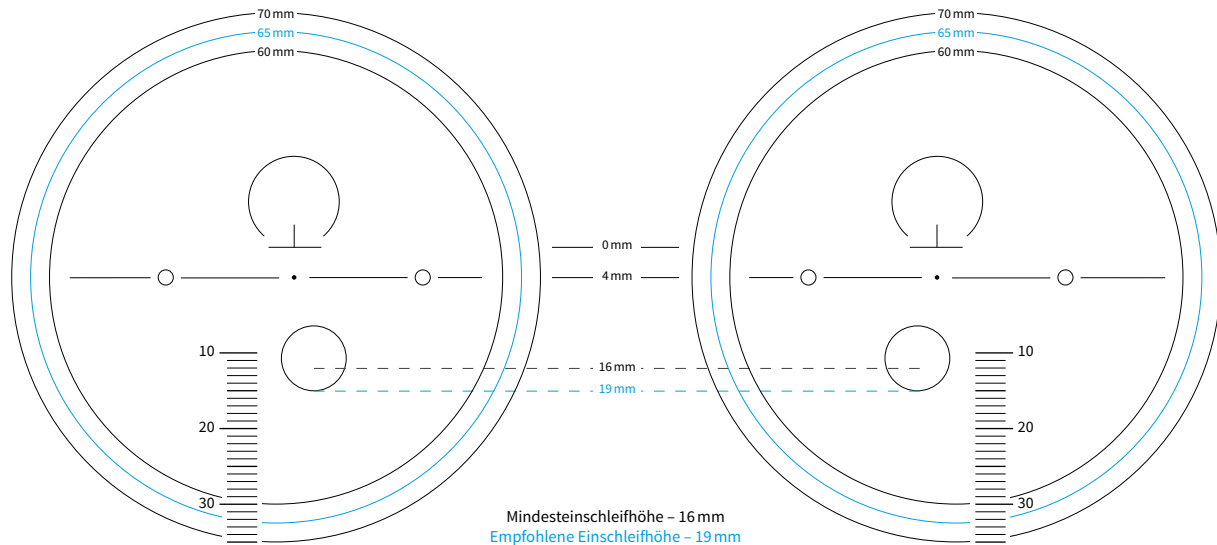

Mineral Perfect – Korridor 8 | 10 | 12 | 14 mm

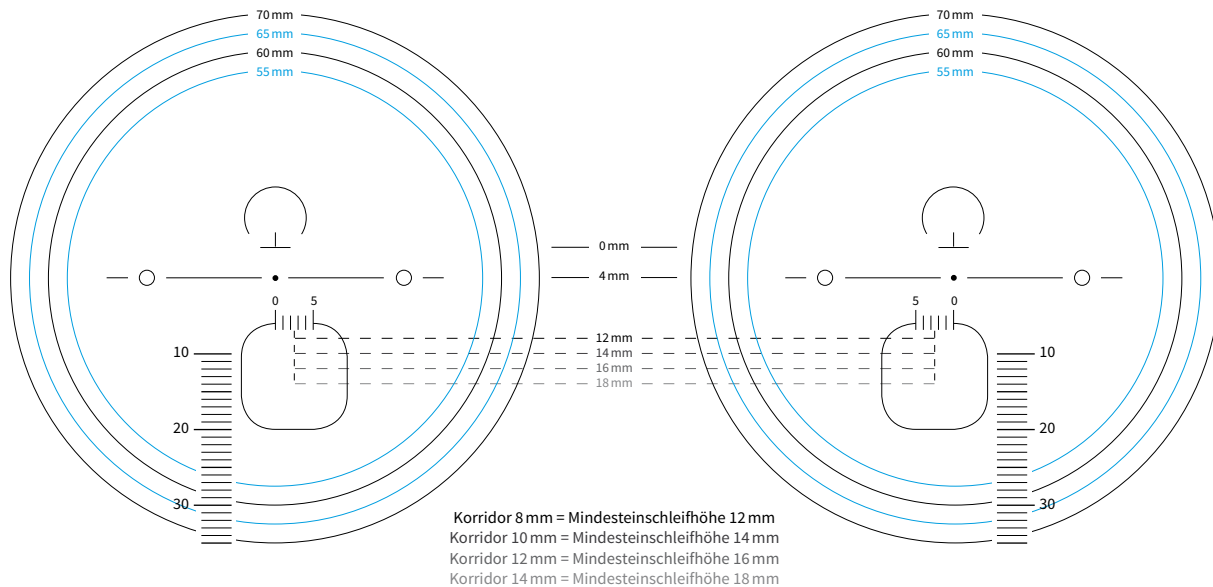

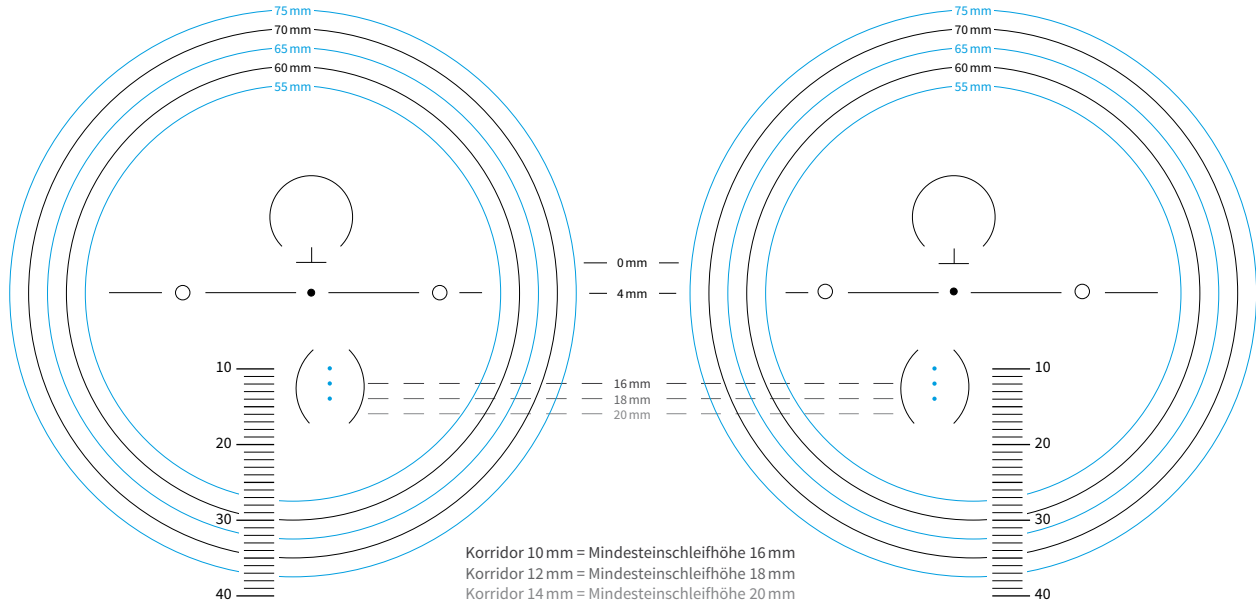

• = Nahreferenzmeßpunkt

Profiline Bronze

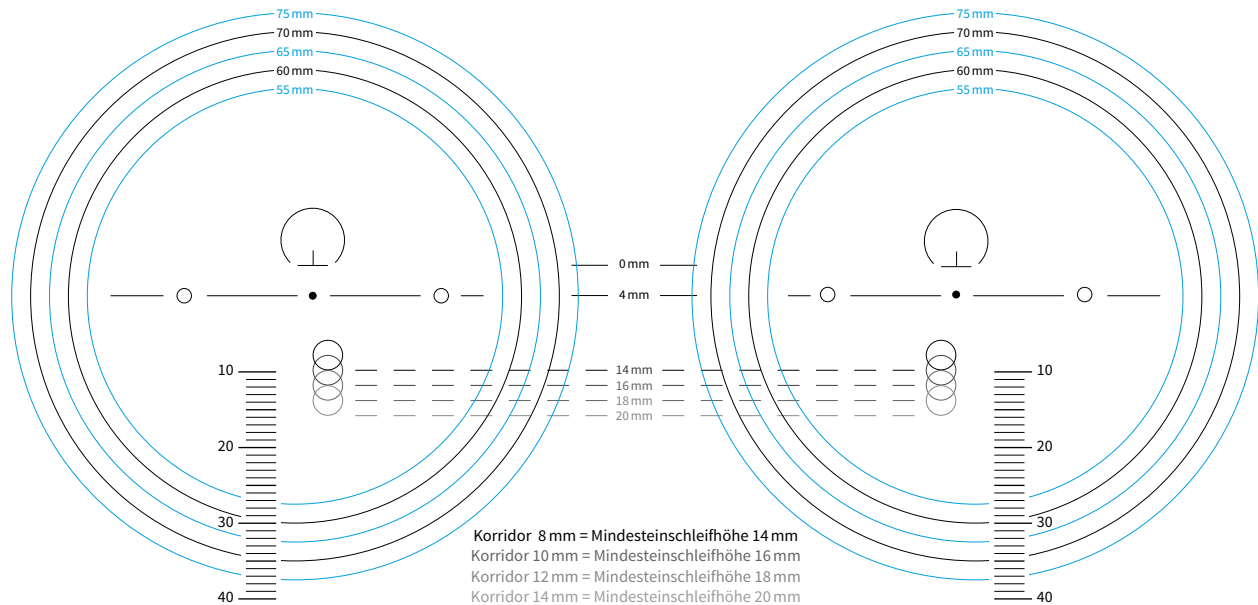

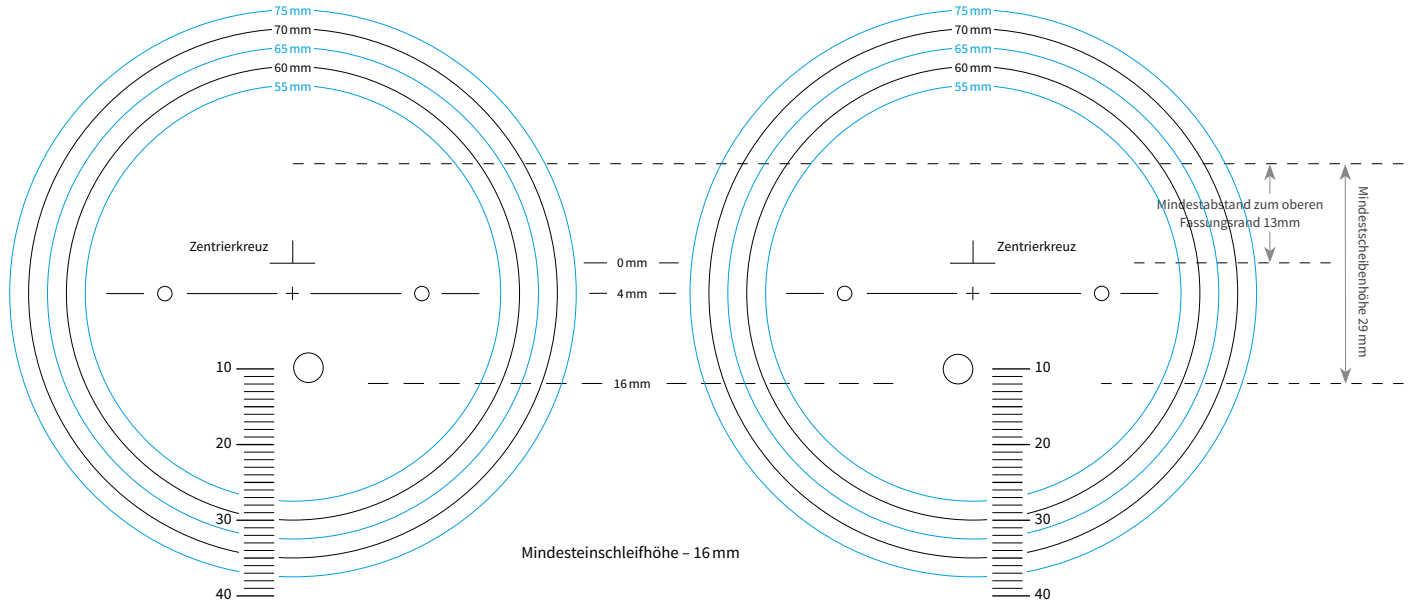

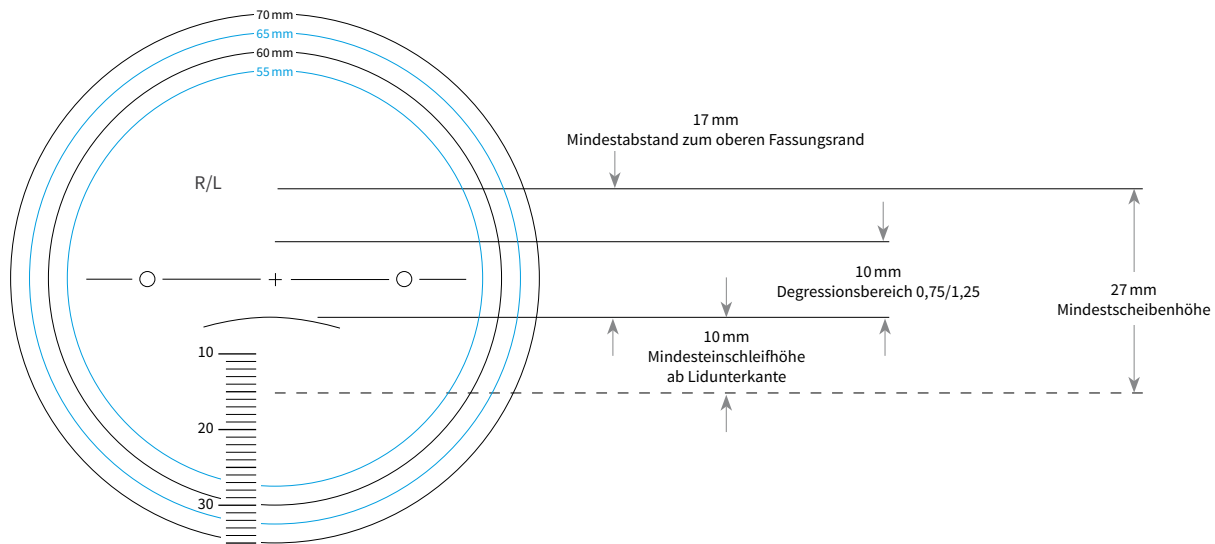

Organic / Mineral Duo FT28 | CT28 | Duo λ Kantenfilter

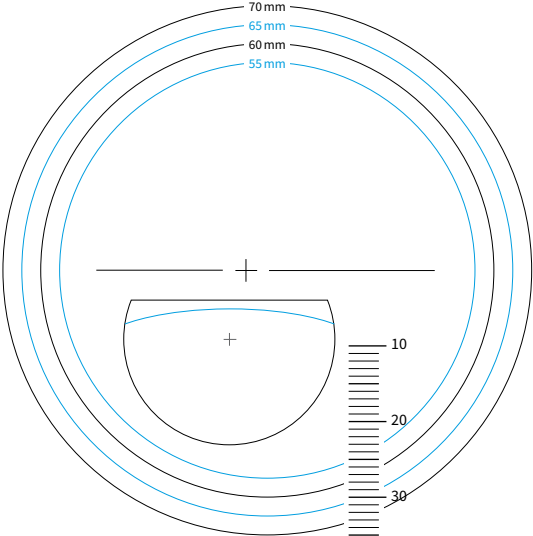
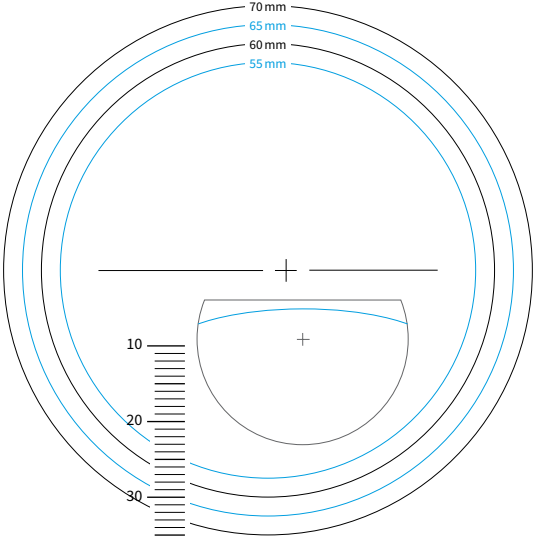

BOW Berliner Optik Welt GmbH

Motzener Straße 9
DE-12277 Berlin

Telefon: +49 (0)30 754 4989 - 0
Fax: +49 (0)30 754 4989 - 29
E-Mail: service@bow-optikwelt.berlin
Internet: www.bow-optikwelt.berlin

Firmensitz: An der Roßweid 1a
DE-76229 Karlsruhe
Geschäftsführer: Hermann Haug
Handelsregister: Amtsgericht Mannheim
HRB Mannheim: 107 388
Umsatzsteuer-ID: DE 17 767 5789